

IMPELLER & COUPLEUR TOOL

ARRACHE HELICE / HOLDER TOOL

Origine & Racing

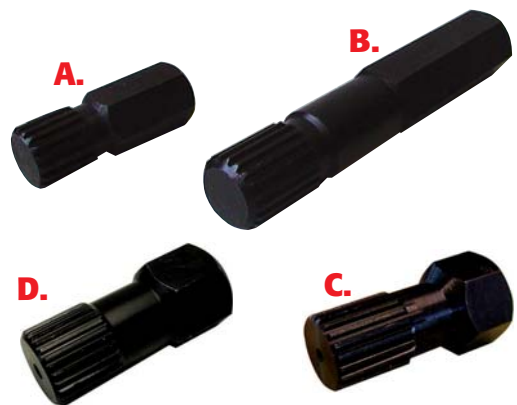

SEA.DOO - POLARIS

DESCRIPTION	REFERENCE	PRICE
A. 580 / 650 / 720 / 800 / 951 All 18 mm	003-313	19.45€ E
B. Polaris All & Long reach univ 20 mm	RWRPOLSW	26.76€ E
C. Sea-Doo 4Tec/Supercharge 23mm	RWSEASW23	29.95€ E
D. Sea-DooRXP/RXT 28mm	RWSEASW28	29.95€ E

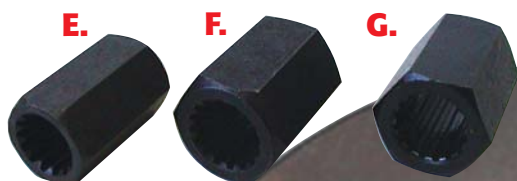

YAMAHA

DESCRIPTION	REFERENCE	PRICE
E. WR500, WJ 650 LX 16 mm	000.315	23.75€ C
F. 650 / 701 / 760 / 1100 / 1200 18 mm	000.316	17.95€ C
G. GP 1200R 20 mm	000.316.01	20.70€ C

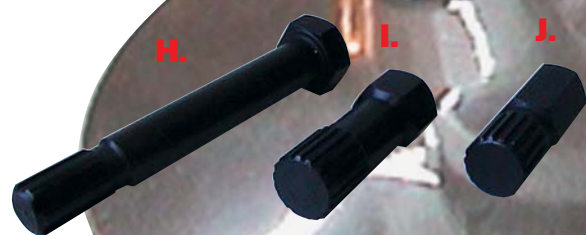

KAWASAKI

DESCRIPTION	REFERENCE	PRICE
H. 440 / 550-89 16 mm	003-312	23.85€ C
I. 650 18 mm	003-313	19.45€ C
J. 750 / 900 / 1100	003-313-01	19.45€ C
K. 1200R / 12F / 15F	003-313-02	19.45€ C

DEMONTE COUPLEUR / COUPLEUR TOOL

Origine & Racing



DESCRIPTION	REFERENCE	PRICE
650 / 701	003-314	49.95€ E
760 / 800 / 1100 / 1200	003-314-01	49.95€ E

ARRACHE VOLANT

KAWASAKI

DESCRIPTION	REFERENCE	PRICE
Fly Wheel Puller 300 / 440 / 550 / 650 / 750 all 18 x 1.5 Special Bolt	003-317	17.85€ E
Fly Wheel Puller 900 / 1100 35 x 1.5 Special Bolt	003-318	59.85€ E



KAWASAKI - YAMAHA

DESCRIPTION	REFERENCE	PRICE
3 Hole Disc / 8 mm Bolts Kaw 300 / 440 / 550 / 650 Removes Flywheel from Crankshaft. Yam 500 / 650 / 701 / 1100 / 1200	003-319	39.95€ E



POLARIS

DESCRIPTION	REFERENCE	PRICE
Polaris all 12 Hole Disc 8 mm Bloles	003-323	79.65€ E



SEA.DOO

DESCRIPTION	REFERENCE	PRICE
Mag / Fly Wheel Puller for 800 / 951	003-321	58.63€ E
Mag / Fly Wheel 580 / 650 / 720 All	003-322	58.61€ E



ARRACHE VOLANT / RAD WRENCH Origine & racing

REFERENCE	O.E	MODEL	YEAR	PRICE
200-110	YAMAHA	All	All	239.95€ F
200-110	KAWASAKI	All	All	239.95€ F
200-110	SEA.DOO	All	All	239.95€ F
200-110	POLARIS	All	All	239.95€ F



COUPE NETTE

Effectuez des découpes nettes grâce au Mini-stripper. Fil Anti-parasite.

DESCRIPTION	REFERENCE	PRICE
Mini-stripper-crimper	00-00-1510	7.85€ E

TESTEUR DE FILS DE BOUGIE

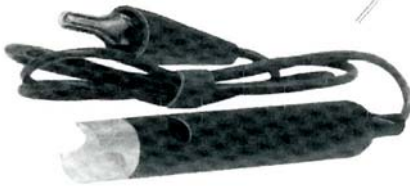

Permet de contrôler l'état des fils d'anti-parasite. Indication par signal lumineux.

DESCRIPTION	REFERENCE	PRICE
SPARK PLUG WIRE TESTER	LS26900	11.90€ E
REPLACEMENT BULD ASSEMBLY	LS26970	2.92€ E

CALLEUR D'ELECTRODE

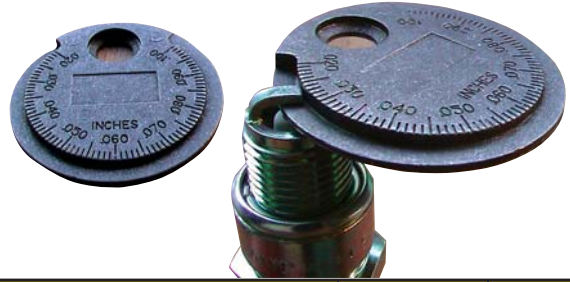

DESCRIPTION	REFERENCE	PRICE
SPARK PLUG GUAGE & GAPPER	LS67870	3.48€ E

MACHOIRES

B.

C.

D.

PN00-00-1519 PN00-00-1517 PN00-00-1516



PINCE A SERTIR MSD



A.

DESCRIPTION	REFERENCE	PRICE
A. PRO-CRIMP TOOL	00-00-1515	109.30€ E
B. Replacement Spark Plug Jaws	00-00-1519	35.50€ E
C. Crimp Jaws for amp Lugs	00-00-1517	38.60€ E
D. Crimps Jaws for amp Pins	00-00-1516	38.60€ E

EXTRACTEUR DE PIN



DESCRIPTION	REFERENCE	PRICE
Weathertight Pin Extracting Tool	00-00-1525	18.85€ E



PINCE POSE PIN

DESCRIPTION	REFERENCE	PRICE
Weathertight Crimping Tool	00-00-1514	55.80€ E

ELECTRICAL

JUMPER CABLE

Cables électriques spécial Waterproof

DESCRIPTION	REFERENCE	PRICE
FLEXIBLE UV LED LEAK DETECTOR	LS36000	37.50€ E
REPLACEMENT BULD ASSEMBLY	LS36090	23.60€ E

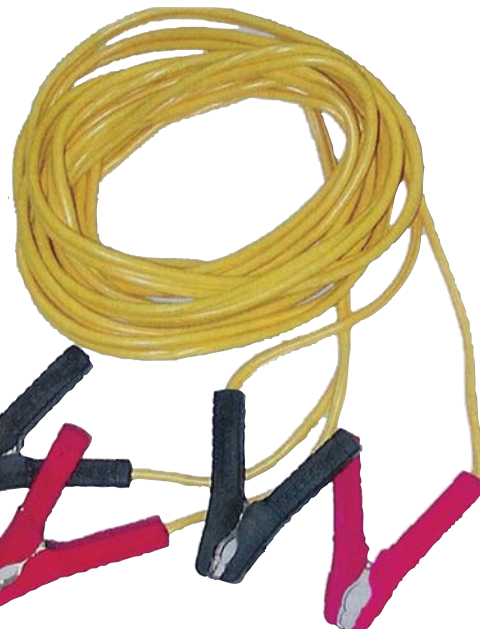

CHARGEUR & MAINTENEUR DE CHARGE 2 en 1

Il suffit de la brancher et c'est tout !
Il stoppe seul et s'enclenche automatiquement lorsque cela est nécessaire.

Voyant de contrôle de charge.



UV DETECTEUR DE FUITE



APPLICATION	REFERENCE	PRICE
Battery Tender Automatic	PC900	59.95€ E
Battery Tender Plus Automatic	PC1800	69.95€ E
Battery Tender "WATERPROOF"	022-0150	49.50€ E

TESTEUR D'ELECTRIQUE



DESCRIPTION	REFERENCE	PRICE
IGNITION SYSTEM SPARK TESTER	59-0253	19.25€ E

DESCRIPTION	REFERENCE	PRICE
FLEXIBLE UV LED LEAK DETECTOR	LS36000	37.50€ E
REPLACEMENT BULD ASSEMBLY	LS36090	23.60€ E

EXTRACTEUR DE FUSIBLE

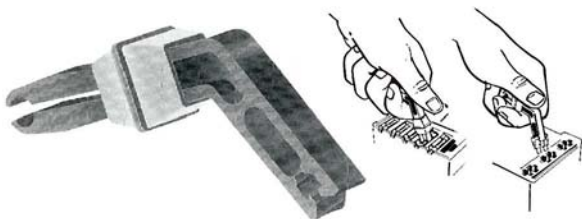

DESCRIPTION	REFERENCE	PRICE
FUSE EASY / Pince à fusible	LS55200	4.55€ E

TESTEUR DE FILS



DESCRIPTION	REFERENCE	PRICE
LOW CIRCUIT TESTER	LS26250	12.85€ E
REPLACEMENT BULD	LS26270	2.07€ E



SIPHON PUMP

DESCRIPTION	REFERENCE	PRICE
Deluxe Siphon Pump	A4110	29.95€ A



POMPE A VIDANGE

DESCRIPTION	REFERENCE	PRICE
OIL EXTRACTOR	OIL01	71.50€ A

RATIO



DESCRIPTION	REFERENCE	PRICE
RATIO + COUVERCLE	RATIO-C	13.95€ A

COLLIER INOX

REFERENCE	DESIGNATION	PRICE
FAC102088	COLLIER INOX FACTORY PIPE 8/12	2.99€ A
FAC102089	COLLIER INOX FACTORY PIPE 10/16	2.99€ A
FAC102090	COLLIER INOX FACTORY PIPE 12/20	3.02€ A
FAC102091	COLLIER INOX FACTORY PIPE 16/25	3.30€ A
FAC102092	COLLIER INOX FACTORY PIPE 20/32	3.70€ A
FAC102093	COLLIER INOX FACTORY PIPE 25/40	3.81€ A
FAC102094	COLLIER INOX FACTORY PIPE 32/50	3.86€ A
FAC102095	COLLIER INOX FACTORY PIPE 40/60	3.92€ A
FAC102096	COLLIER INOX FACTORY PIPE 60/80	4.06€ A
FAC102104	COLLIER INOX FACTORY PIPE 80/100	4.61€ A
FAC102105	COLLIER INOX FACTORY PIPE 90/100	4.74€ A
FAC102106	COLLIER INOX FACTORY PIPE 100/120	4.87€ A
FAC102107	COLLIER INOX FACTORY PIPE 120/140	5.24€ A
FAC102108	COLLIER INOX FACTORY PIPE 140/180	5.78€ A

COLIERS RILSANS



DESCRIPTION	REFERENCE	PRICE
Risellant Primer 100 pcs	64-0050	7.95€ E
Risellant Water 100 pcs	64-0051	14.95€ E



STAINLESS STUD PACKS

DESCRIPTION	REFERENCE	PRICE
6 X 45 8 pcs	62-3045	19.80€ E
8 X 30 8 pcs	62-4030	19.80€ E



STONE-TYPE GLAZE

DESCRIPTION	REFERENCE	PRICE
Deglass cylinder watercraft / ATV réglable de 50,8 à 177,8 mm	LS23500	48.71€ E
Patin de remplacement	LS23520	12.90€ E

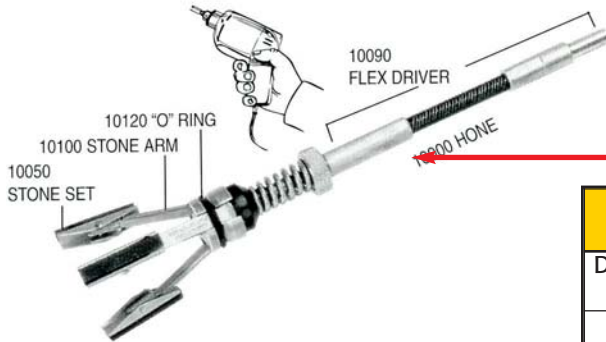
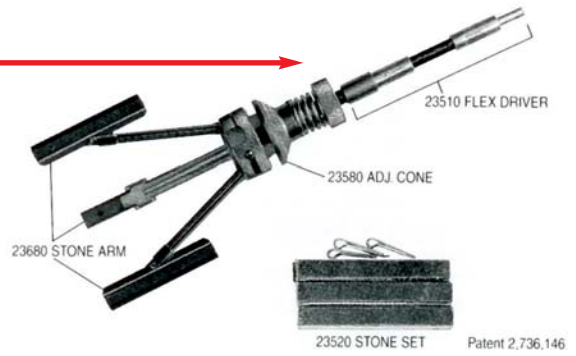

CYLINDER HONES

DESCRIPTION	REFERENCE	PRICE
Deglass cylinder watercraft / ATV réglable de 21,4 à 50,8 mm	LS10000	24.85€ E
Patin de remplacement	LS10050	7.90€ E

PINCE POSE SEGMENT



INSERT PISTON

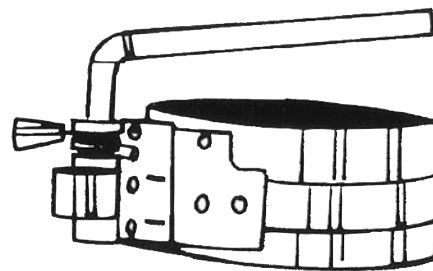

DESCRIPTION	REFERENCE	PRICE
QUICK RING COMPRESSOR	LS19000	25.70€ E

DESCRIPTION	REFERENCE	PRICE
PISTON RING INSTALLER	LS33500	8.45€ E

PINCE POSE CAGE A AIGUILLES



DESCRIPTION	REFERENCE	PRICE
PISTON PIN PULLER	59-0252	32.65€ E

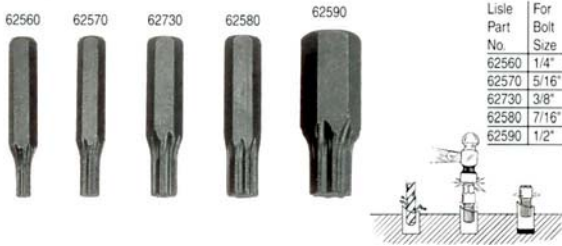

KIT ARRACHE GOUGONS

A super strong extractor set made of the special hardwared, shock-resistant tool steel. Works on both left and right hand threads.

DESCRIPTION	REFERENCE	PRICE
Super Out Extractor set	LS62900	26.93€ E

TOURNE VIS A CHOC



DESCRIPTION	REFERENCE	PRICE
Impact Drive Set	LS29200	69.80€ E

RECONDITIONNEMENT DE PAS DE BOUGIE



DESCRIPTION	REFERENCE	PRICE
Spark plug hole thread chaser	LS20200	9.76€ E

PINCE A BRIDE DE SERRAGE (sea-Doo)



DESCRIPTION	REFERENCE	PRICE
CV BOOT CLAMP PLIERS	LS30500	34.68€ E

COLIERS CLAMPS O.E

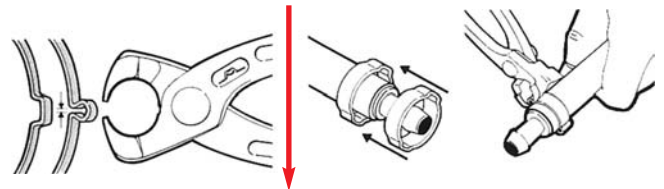

DESCRIPTION	REFERENCE	PRICE
Clamps for 1/4" Hose 10 pcs	59-4016	7.45€ E
Clamps for 3/8" Water line 10 pcs	59-4017	8.25€ E
Clamps for 1/2" Water line 10 pcs	59-4018	9.10€ E

PINCE COUPANTE DURITE

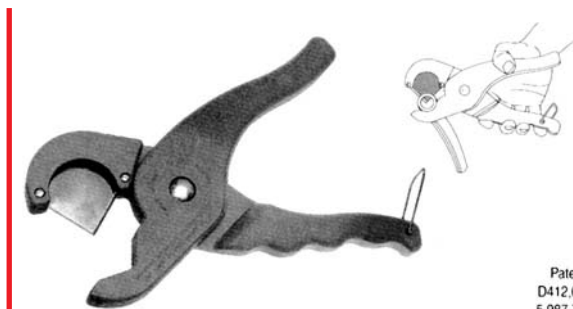

Patents
D412,095
5,987,750

DESCRIPTION	REFERENCE	PRICE
HOSE SHEARS	LS11420	32.80€ E

COLIERS CLAMPS O.E



DESCRIPTION	REFERENCE	PRICE
HOSE REMOVAL PLIERS	LS47900	13.90€ E

PINCE TUYAU

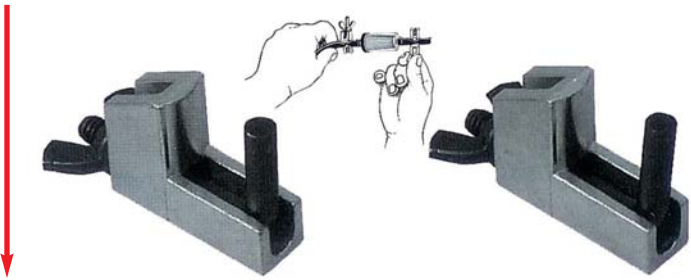

DESCRIPTION	REFERENCE	PRICE
HOSE PINCHERS vendus par 2	LS22850	6.25€ E pcs

RACLETTE STICKERS



DESCRIPTION	REFERENCE	PRICE
FOLD-UP SCRAPER	LS52400	12.45€ E

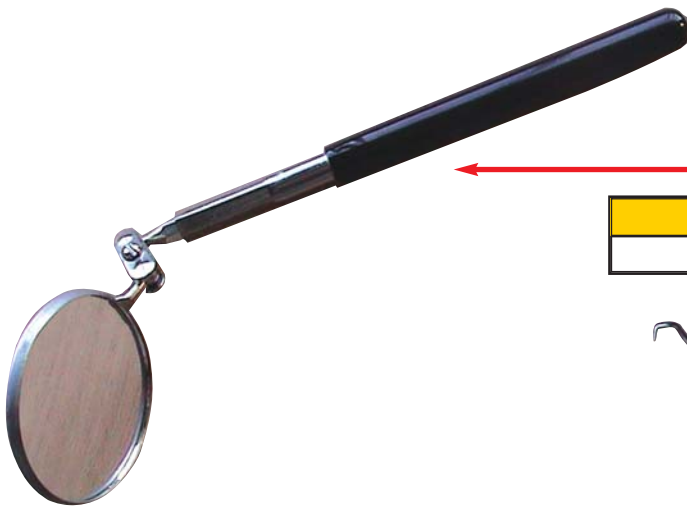

MIRROIR TELESCOPIQUE

DESCRIPTION	REFERENCE	PRICE
TELESCOPING MIRROR	LS32050	15.47€ E



PIC A GORGE

DESCRIPTION	REFERENCE	PRICE
"O" RING AND SEAL PICK	LS31840	10.25€ E

CUTTER A PLAN DE JOINT

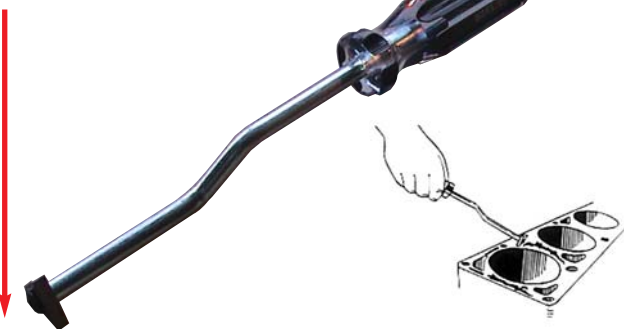

DESCRIPTION	REFERENCE	PRICE
CARBIDE GASKET SCRAPER	LS51650	21.33€ E

REGLAGE CARBURATEUR 90°

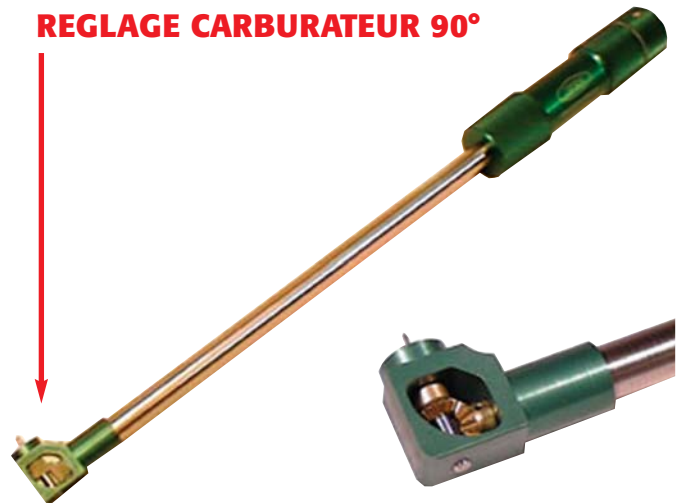

DESCRIPTION	REFERENCE	PRICE
90 DEGREE 1/8" HEX DRIVER	T01000	129.40€ E

INDICATEUR

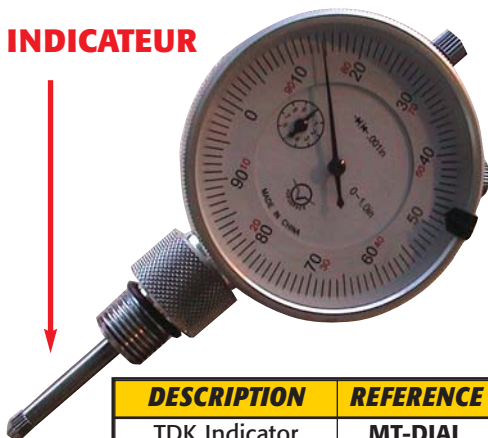

DESCRIPTION	REFERENCE	PRICE
TDK Indicator	MT-DIAL	79.25€ F

OUTIL POSE CABLE DE DIRECTION



DESCRIPTION	REFERENCE	PRICE
STEERING CABLE INSTALLATION TOOL	59-0208	85.60€ F

GRAISSEUR DE CABLES

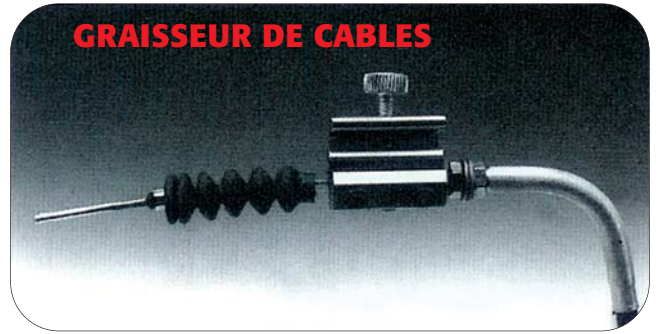

DESCRIPTION	REFERENCE	PRICE
Cable Lubber	59-0250	8.90€ E

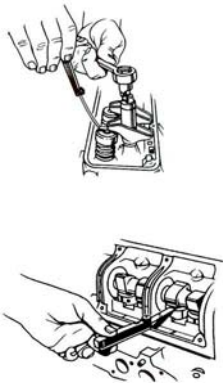

Blade Sizes		
Inches	mm	Inches
.0015	.038	.016
.002	.051	.017
.0025	.064	.018
.003	.076	.019
.004	.102	.020
.005	.127	.021
.006	.152	.022
.007	.178	.023
.008	.203	.024
.009	.229	.025
.010	.254	.026
.011	.279	.028
.012	.305	.030
.013	.330	.032
.014	.356	.035
.015	.381	

DELUXE FEELER GAUGE

Lamelles de mesure de précision pour un calage parfait 'arbre à cames, soupapes, ...

DESCRIPTION	REFERENCE	PRICE
Deluxe feeler gauge	LS68100	14.81€ F

VALVE SPRING COMPRESSOR

Démontez et remontez facilement vos ressorts de soupape.

DESCRIPTION	REFERENCE	PRICE
Valve spring compressor	LS16750	51.77€ F

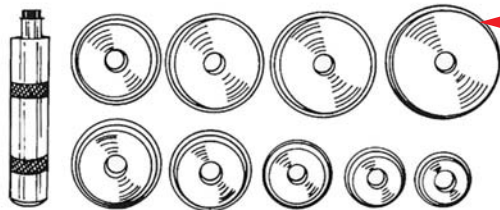
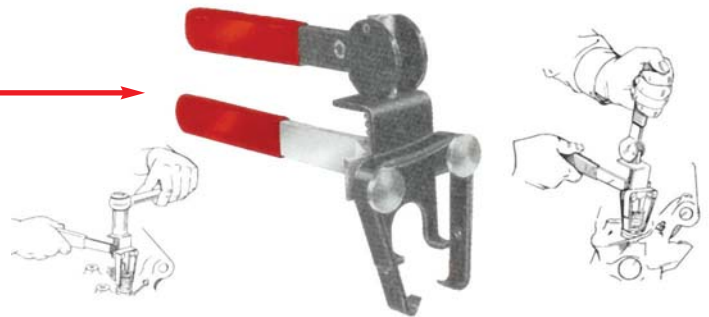

POSE ROULEMENT KIT

APPLICATION	REFERENCE	PRICE
Bearing Race and Seal Drive	LS12980	89.75€ E
Handle Mini Pouched	LS12660	12.30€ E

SET INCLUDES ONE OF EACH OF THE FOLLOWING DRIVERS:

DRIVER PART NO.	SIZE
12610	1.565"
12620	1.750"
12630	1.965"
12640	2.325"
12710	2.470"
12650	2.555"
12690	2.830"
12700	2.995"
12970	3.180"

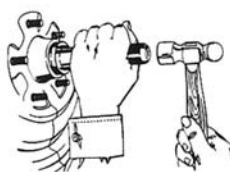

EXTRACTEUR DE JOINT ETANCHE

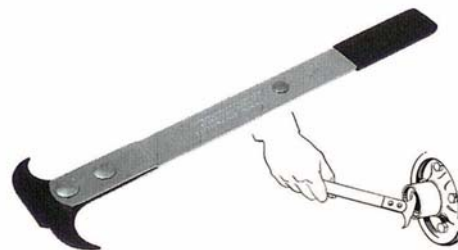

DESCRIPTION	REFERENCE	PRICE
Seal Puller	LS65750	9.35€ E

STRUT TOLL UNIVERSAL

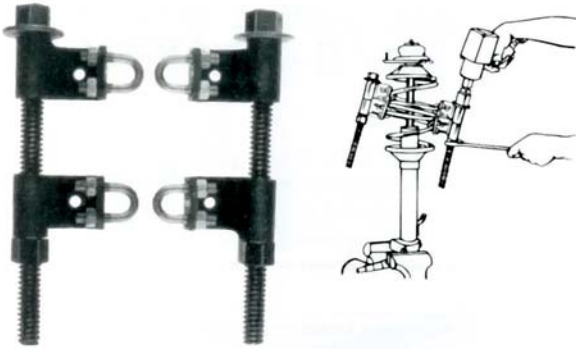

Compresseur de ressort d'amortisseur.

DESCRIPTION	REFERENCE	PRICE
STRUT TOOL ATV	LS62300	109.72€ E

LIFTING SLING



DESCRIPTION	REFERENCE	PRICE
Pince levage Jet 1-2 Places	RY1027	249.50€ E
Pince levage Jet 3 Places	RY1027-20	349.50€ E

MACHOIRE ALUMINIUM

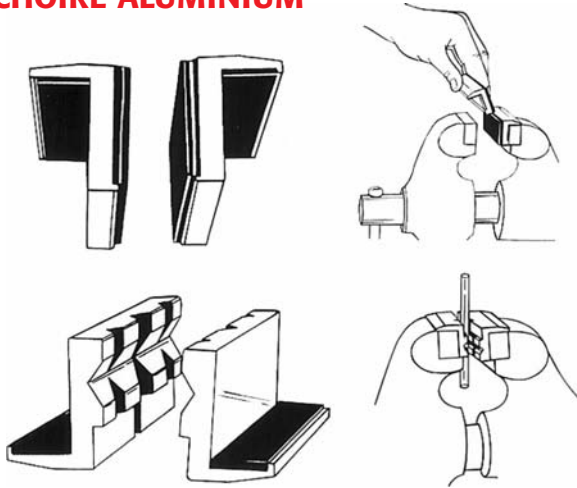

APPLICATION	REFERENCE	PRICE
RUBBER-FACED VISE JAW PADS	LS48100	16.90€ E
ALUMINUM VISE JAW PADS	LS48000	15.30€ E

CLEFS



Part#	Wrench Size
42660	10mm
42670	8mm
42680	6mm
42690	5mm
42700	4mm
42710	3mm
42720	2.5mm
42730	2mm
42740	1.5mm

DESCRIPTION	REFERENCE	PRICE
BALL END ALLEN SET	LS42650	15.90€ E

MALETTE DE CLEF A DOUILLE



DESCRIPTION	REFERENCE	PRICE
Pièce malette des clés à douilles 45 pièces 1/4" et 3/8"	GERE1049	79.90€ E

MALETTE DE CLEF A DOUILLE



DESCRIPTION	REFERENCE	PRICE
Pièce malette de clés à douilles 93 pièces 1/4" et 1/2"	GERE1048	149.90€ E

MANUEL WATERCRAFT



*manuals are
the most user-friendly
personal watercraft repair
manuals available
today...*

KAWASAKI

1976-1991
JS300, 300SX, 400, 440, 440SX, 550, 550SX,
650SX; JF650X2, 650TS; JL650SC; JB650 (Jet
Mate) - 608 pgs/Trim Size 8.25 x 10.875

Book No. W801 PRICE : 54.95€

1992-1994
JS440SX, 550SX; JB650 Jet Mate; JF650X2,
650TS; JL650SC; JS650SX; JH750SS, 750SX,
750Xi, 750XiR, JT750ST
488 pgs/Trim Size 8.25 x 10.875

Book No. W802 PRICE : 54.95€

1976-1994
Performance Manual. ALL MODELS
192 pgs/Trim Size 8.25 x 10.875

Book No. W804 PRICE : 54.95€

MERCURY

Sport Jet 90-120 hp, 1993-1995
192 pgs/Trim Size 8.25 x 10.875

Book No. W815 PRICE : 54.95€

POLARIS

1992-1995
SL650, SL650 Std., SL750, SLT750 - 296
pgs/Trim Size 8.25 x 10.875

Book No. W804 PRICE : 54.95€

1996-1998
SL700, SLT700, SL700 Deluxe, Hurricane,
SL780, SLT780, SL900, SL1050, SLTX, SLH,
SLTH, SLXH - 296 pgs/Trim Size 8.25 x 10.875

Book No. W820 PRICE : 54.95€

SEA-DOO

1988-1996
Standard, GT, GTS, GTX, GTI, GSX, HX, SP,
XP, SPi, SPX, XP-800 - 592 pgs/Trim Size 8.25
x 10.875

Book No. W809-3 PRICE : 54.95€

1997-2001
GS, GSI, GSX Series, GTI, GTS, GTX Series,
HX, LRV, RX Series, SP, SPX, XP Series
450 pgs/Trim Size 8.25 x 10.875

Book No. W810 PRICE : 54.95€

YAMAHA

1987-1992
WJ500, WR500, WR650, WRA650, WRB650,
SJ650 - 400 pgs/Trim Size 8.25 x 10.875

Book No. W805 PRICE : 54.95€

1993-1996
WR500, SJ650, WR650, WRA650, WRA650A,
WRB650, WRB650A, FX700, SJ700, SJ700A,
RA700, RA700A, RA700B, WB700A, WRA700,
WRB700, WVT700, RA760, WB760, RA1100,
WVT1100 - 576 pgs/Trim Size 8.25 x 10.875

Book No. W806 PRICE : 54.95€

CLYMER® ProSeries PERSONAL WATER VEHICLE SERVICE MANUAL

1980-1988
Fazer, Funjet Boat, Jet Ski, Scat Hovercraft,
Surf-Jet, Wetbike, Wetjet, Yamaha
128 pgs/Trim Size 8.125 x 10.875

Book No. PWV-1 PRICE : 39.95€